

## WORKRITE POISE

monitor arms



### CHANGE THE WAY YOU SEE YOUR WORK

The Workrite Poise monitor arm features a parallel linkage design with adjustable pneumatic counter balance that floats the monitor above the work surface. A simple touch with your fingertip will easily change the position of the Workrite Poise while the monitor remains perfectly parallel.

The Workrite Poise has a range of adjustment to meet users' need for visual acuity and individual user preference that is unmatched in the industry as well as several thoughtful features built in. Graphic indicators are molded into the arm to assist in adjustment long after installation. The cable management system neatly organizes cables out of sight. Optional features include multiple mounting options and quick release monitor bracket for installation flexibility.



Let work  
come to Life.™

**Workrite**  
ergonomics

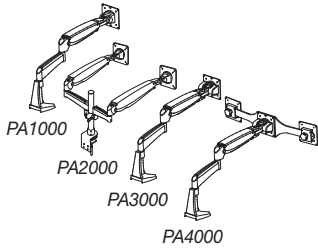

- All configurations feature:**
- 160° tilt range (+70°/- 90°), 360° pivot at base and arm connections, 180° pivot at monitor mounting
  - 4" stored depth
  - Parallel linkage design keeps monitor perfectly parallel when adjusting vertically
  - Adjustable pneumatic counter balance
  - Clamp mount version includes two piece C-clamp and separate grommet clamp (shown) for surfaces of 3/4" - 2 1/8" thickness
  - For customized control, including touch-screen use, tension is adjustable at all pivot points
  - Integral cable management neatly stores cables
  - For security, monitor attached with 4 screws
  - VESA monitor mount for 75mm and 100mm standard
  - Optional VESA bracket for VESA 100 mm x 200 mm mounting for all single monitor applications
  - 80% recyclable at end of life
  - 10 year warranty

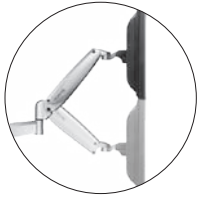

Parallel mechanism keeps screen ergonomically correct



Poise spans the deepest desk then folds down to just 4"



Increase productivity with Twin monitor configurations in vertical or horizontal orientation

- Single configuration features:**
- Supports monitors up to 22 lbs.
  - 23 1/4" reach, 17 1/2" height range
  - 180° rotation of monitor to quickly change from landscape to portrait orientation

- Extended configuration features:**
- All the features of Poise PA1000 plus an additional extension arm provides 7" more horizontal reach - 30 1/4" total reach

- Heavy Duty configuration features:**
- All the features of the Poise PA1000 plus additional support for monitors from 18 lbs. up to 42 lbs.

- Twin configuration features:**
- All the features of the Poise PA1000 plus additional support for two monitors from 7 lbs. up to 18 1/2 lbs. each
  - Can be installed for either landscape or portrait orientation both vertically or horizontally
  - Actual (not diagonal) monitor width not to exceed 20 1/2" each
  - Twin mounting plate orients monitors slightly inward towards viewer

- Dual configuration features:**
- All the features of the Poise PA1000 plus additional support for two monitors on two articulating arms
  - Each arm supports monitors up to 22 lbs. and has 23 1/4" reach

Configuration	Mounting	Color	Model #	Weight
Single	C-Clamp & Grommet Mount (shown)	Silver	PA1000-S	12
		Graphite	PA1000-B	12
	Sierra Tool bar & Privacy Panel	Silver	PA1000-ST-S	11
		Graphite	PA1000-ST-B	11
	Wall mount & other tool bar & panel systems †	Silver	PA1000-WM-S	11
		Graphite	PA1000-WM-B	11
Slatwall bracket mount	Silver	PA1000-SW-S	11	
	Graphite	PA1000-SW-B	11	
Extended	C-Clamp & Grommet Mount	Silver	PA1500-DB-S	13
		Graphite	PA1500-DB-B	13
Heavy Duty	C-Clamp & Grommet Mount	Silver	PA3000-S	13
		Graphite	PA3000-B	13
Twin	C-Clamp & Grommet Mount	Silver	PA4000-S	18
		Graphite	PA4000-B	18
Dual	C-Clamp Mount	Silver	PA2000-C-S	18
		Graphite	PA2000-C-B	18
	Grommet Mount	Silver	PA2000-G-S	17
		Graphite	PA2000-G-B	17
		<b>Size</b>		
Accessories	VESA Bracket	100mm x 200mm	PA-MIS-E	2

† NOTE: Must order panel mount separately (see Pricing and Specification Guide)



**Statement of Line:**

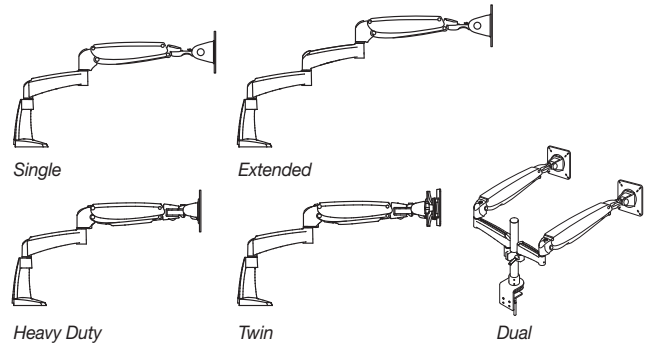

**Specifications:**  
**Reach**

Single, Heavy Duty & Twin

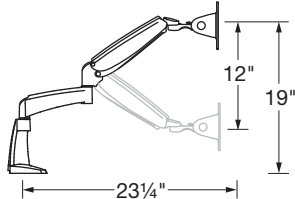

Extended

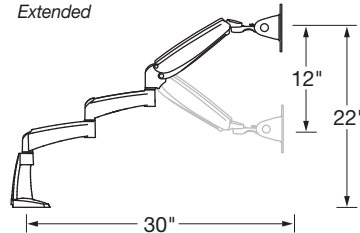

Stowed depth



Twin mounts

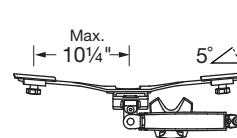

Pivot & tilt

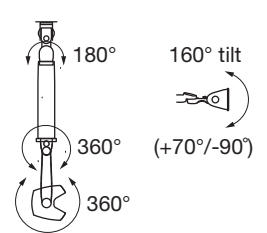

Workrite Ergonomics, Inc. 1450 Technology Lane, Petaluma, CA 94954  
www.workriteergo.com 800.959.9675

©2011 Workrite Ergonomics | All referenced company and product names are trademarks, registered trademarks or copyrights of their respective holders.  
1400219-0311 Subject to change without notice.